

ADEKA ULTRA SEAL

P-201

OCM, Inc.

Sales Information: (847) 955-9700

Technical Information: (800) 999-3959

www.adeka.com

PRODUCT DESCRIPTION:

Single component grey urethane paste.

PACKAGING INFORMATION:

24 Cartridges / Case

10.8 ounces per cartridge

EXPANSION INFORMATION BY VOLUME

Approximately 100% (In House)

HYDROPHILIC WATERSTOP IN A CARTRIDGE

One of the most versatile Adeka products

GENERAL DESCRIPTION

P-201 is a single component hydrophilic paste used in water-stop and repair applications. It can be placed on damp or uneven surfaces and functions in a wide range of temperatures and ground water conditions.

BASIC USE

P-201 is used in piping penetrations, preventing water penetration in sheet piles, pre-cast concrete joints, and a variety of joint and crack repair applications. It is used in conjunction with formed Adeka water-stops whenever damp or rough surfaces are encountered.

BASIC INSTALLATION

Clean dirt and debris before applying P-201. The area may be damp but must not have standing water. Bead size is controlled by cutting the tip of the cartridge at the proper place. Normal bead size is approximately 0.25 by 0.50 inches. Cut the nozzle at the first notch to obtain that bead size. One cartridge will cover approximately 12 linear feet at a bead size of 0.25 by 0.50 inches. Apply a consistent and continuous bead. Expansion occurs in three dimensions and in the direction of least resistance. Therefore P-201 must be encapsulated or injected into a crack or joint in order to function properly. It is not suitable for a surface application. Allow time for P-201 to cure before placing concrete.

INSTALLATION

PIPING PENETRATIONS

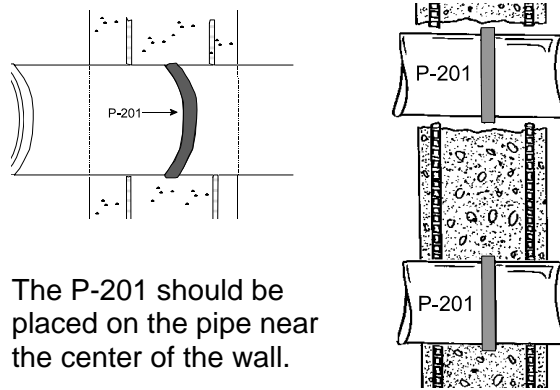

The P-201 should be placed on the pipe near the center of the wall.

MC-2005T can be used if the pipe diameter exceeds 12 inches. Use MC-2010MN if the diameter is greater than 24 inches. Allow sufficient curing time, 24-36 hours, for the P-201. This is to avoid the possibility of the new concrete pour tearing the P-201 from the pipe.

EXISTING WALL PENETRATIONS

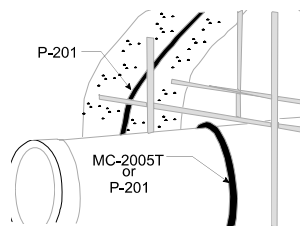

Apply a 1/4" by 1/2" bead of P-201 to the center of the existing wall. Remove any dirt or loose debris before applying the bead.

The surface does not have to be smooth or dry. Apply a consistent and continuous bead.

SHEET PILE INSTALLATION

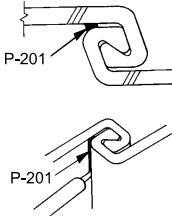

Clean area of dirt and debris. Stop flowing water and inject P-201 into the interlock area as shown. Cut the tip of the nozzle near the tip to produce a small size bead that can be injected into the lock. If the sheet pile is under a hydrostatic head, stop the flow of water with Adeka KM string before applying the P-201.

I - BEAM INSTALLATION

Clean around the area of the I-Beam before placing the P-201. Apply a bead size approximately $\frac{1}{4}$ by $\frac{1}{2}$ inches. Do not allow any gaps in the bead. Overlap and consolidate the area where the beads meet.

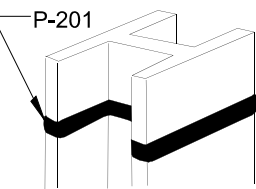

INSTALLATION WITH MC-2010MN

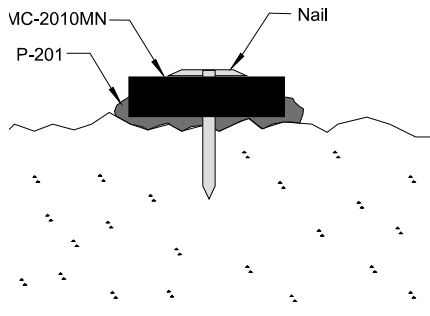

Apply a bead of P-201 before placing MC-2010MN on rough concrete. Apply sufficient P-201 to fill all voids or rough areas.

Use P-201 in any application where an overlap or joining occurs with any other formed water-stop.

SAW CUT CONTROL JOINT

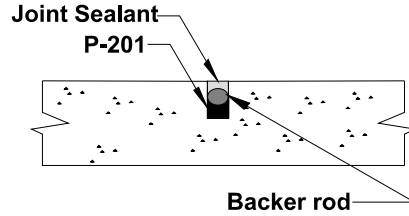

Saw cut the control joint to a depth of 2~ 2½ inches. Inject P-201 into the joint to a depth of $\frac{3}{8}$ ~ $\frac{1}{2}$ inches. Place oversized backer rod on top of the P-201 as an expansion buffer. Backer rod should compress P-201 to a depth of approximately $\frac{1}{4}$ ". Fill the remaining joint area with grout, epoxy or hydraulic cement. There is a chance that the covering material will be lifted off due to the expansion pressure of the P-201 if the backer rod is not in place. Do not place P-201 in a position where it will be exposed to direct sunlight.

ADDITIONAL INSTALLATION EXAMPLES

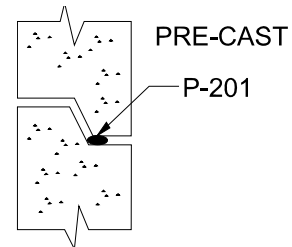
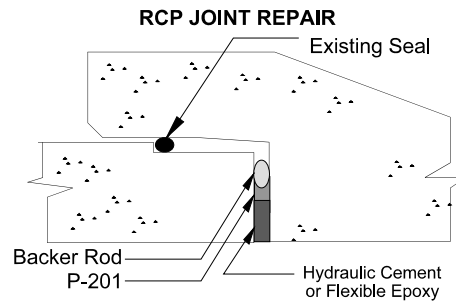

P-201 can be used in pre-cast applications such as utility vaults and storage reservoirs.

P-201 has good resistance to a number of chemical contaminants. Some chemicals in higher concentrations may affect the performance of P-201. Consult your local Adeka representative concerning any unusual chemical contaminants.

Visit www.adeka.com for warranty and more technical information or call (800) 999-3959